



STPS60170C

HIGH VOLTAGE POWER SCHOTTKY RECTIFIER

Table 1: Main Product Characteristics

| | |
|-------------|----------|
| $I_{F(AV)}$ | 2 x 30 A |
| V_{RRM} | 170 V |
| T_j | 175 °C |
| $V_F(max)$ | 0.76 V |

FEATURES AND BENEFITS

- High junction temperature capability
- Low leakage current
- Good trade off between leakage current and forward voltage drop
- Low thermal resistance
- High frequency operation
- Avalanche specification

DESCRIPTION

Dual center tab Schottky rectifier suited for High Frequency Switched Mode Power Supplies. Packaged in TO-220AB, this device is intended for use to enhance the reliability of the application.

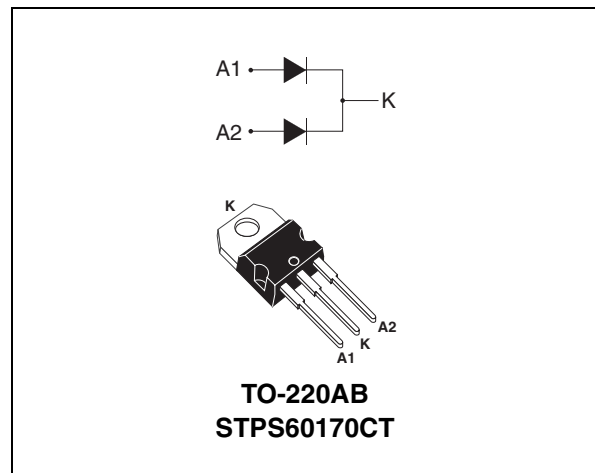

Table 2: Order Code

| Part Number | Marking |
|-------------|-------------|
| STPS60170CT | STPS60170CT |

Table 3: Absolute Ratings (limiting values, per diode)

| Symbol | Parameter | Value | Unit |
|--------------|--|---------------------------------|------------------|
| V_{RRM} | Repetitive peak reverse voltage | 170 | V |
| $I_{F(RMS)}$ | RMS forward current | 60 | A |
| $I_{F(AV)}$ | Average forward current $T_c = 150\text{ °C}$ $\delta = 0.5$ | Per diode: 30 Per device: 60 | A |
| I_{FSM} | Surge non repetitive forward current $t_p = 10\text{ ms sinusoidal}$ | 270 | A |
| P_{ARM} | Repetitive peak avalanche power $t_p = 1\text{ }\mu\text{s}$ $T_j = 25\text{ °C}$ | 17300 | W |
| T_{stg} | Storage temperature range | -65 to + 175 | °C |
| T_j | Maximum operating junction temperature * | 175 | °C |
| dV/dt | Critical rate of rise of reverse voltage | 10000 | V/ μs |

* : $\frac{dP_{tot}}{dT_j} < \frac{1}{R_{th(j-a)}}$ thermal runaway condition for a diode on its own heatsink

Table 4: Thermal Parameters

| Symbol | Parameter | | Value | Unit |
|---------------|------------------|-----------|-------|------|
| $R_{th(j-c)}$ | Junction to case | Per diode | 1.0 | °C/W |
| | | Total | 0.7 | |
| $R_{th(c)}$ | | Coupling | 0.4 | |

When the diodes 1 and 2 are used simultaneously:

$$\Delta T_j(\text{diode 1}) = P(\text{diode 1}) \times R_{th(j-c)}(\text{Per diode}) + P(\text{diode 2}) \times R_{th(c)}$$

Table 5: Static Electrical Characteristics (per diode)

| Symbol | Parameter | Tests conditions | | Min. | Typ | Max. | Unit |
|------------|-------------------------|-----------------------|---------------------|------|------|------|------|
| I_R^* | Reverse leakage current | $T_j = 25\text{ °C}$ | $V_R = V_{RRM}$ | | | 35 | μA |
| | | $T_j = 125\text{ °C}$ | | | 8 | 35 | mA |
| V_F^{**} | Forward voltage drop | $T_j = 25\text{ °C}$ | $I_F = 30\text{ A}$ | | | 0.94 | V |
| | | $T_j = 125\text{ °C}$ | | | 0.72 | 0.76 | |
| | | $T_j = 25\text{ °C}$ | $I_F = 60\text{ A}$ | | 0.97 | 1.05 | |
| | | $T_j = 125\text{ °C}$ | | | 0.86 | 0.92 | |

Pulse test: * $t_p = 5\text{ ms}$, $\delta < 2\%$

** $t_p = 380\text{ μs}$, $\delta < 2\%$

To evaluate the conduction losses use the following equation: $P = 0.60 \times I_{F(AV)} + 0.053 I_F^2(\text{RMS})$

Figure 1: Average forward power dissipation versus average forward current (per diode)

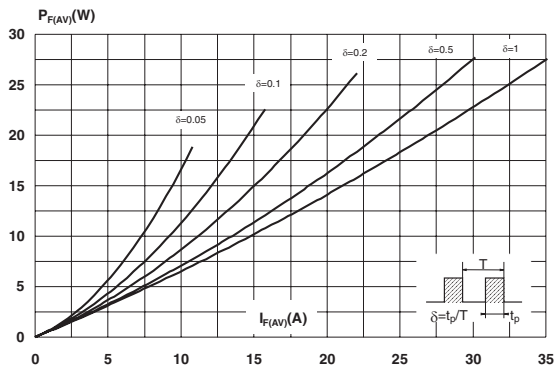

Figure 2: Average forward current versus ambient temperature ($\delta = 0.5$, per diode)

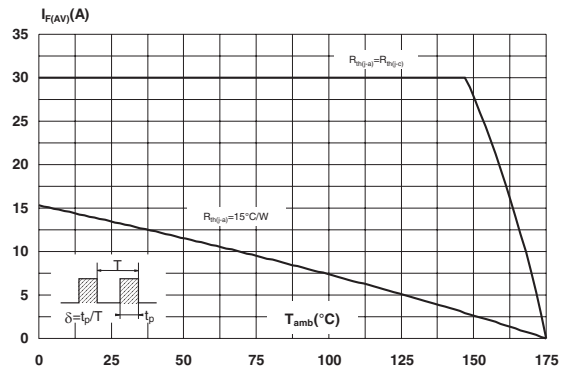

Figure 3: Normalized avalanche power derating versus pulse duration

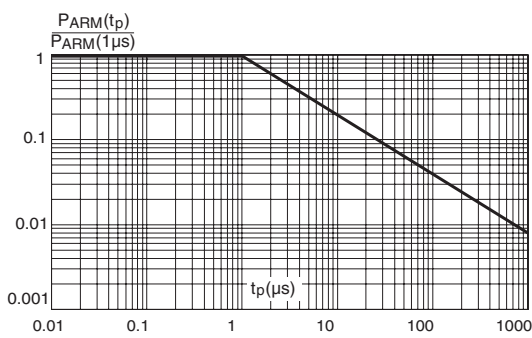

Figure 4: Normalized avalanche power derating versus junction temperature

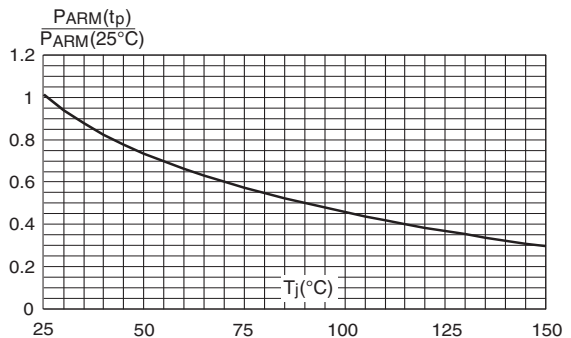

Figure 5: Non repetitive surge peak forward current versus overload duration (maximum values, per diode)

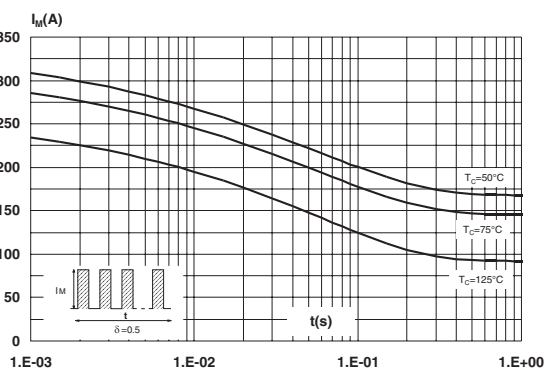

Figure 6: Relative variation of thermal impedance junction to case versus pulse duration

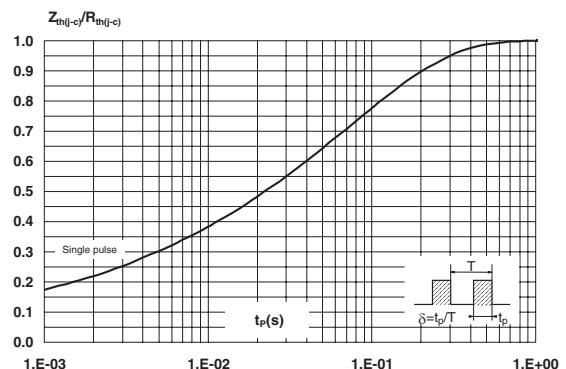

Figure 7: Reverse leakage current versus reverse voltage applied (typical values, per diode)

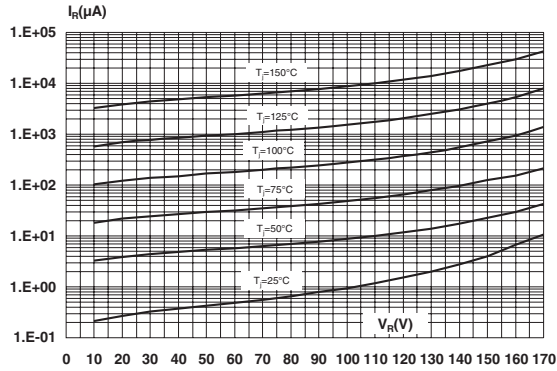

Figure 8: Junction capacitance versus reverse voltage applied (typical values, per diode)

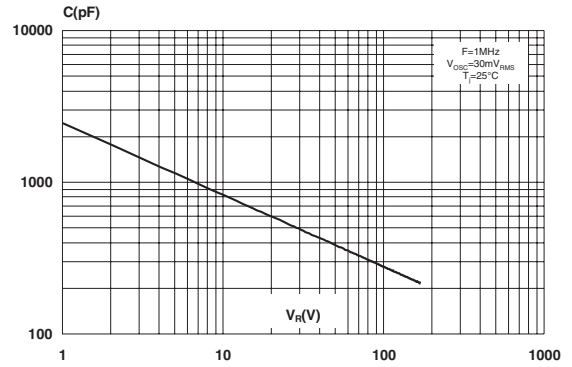

Figure 9: Forward voltage drop versus forward current (per diode, low level)

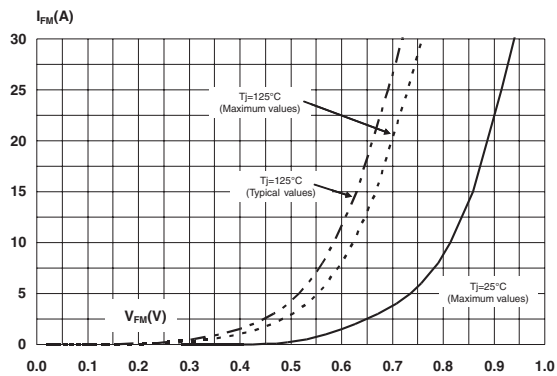

Figure 10: Forward voltage drop versus forward current (per diode, high level)

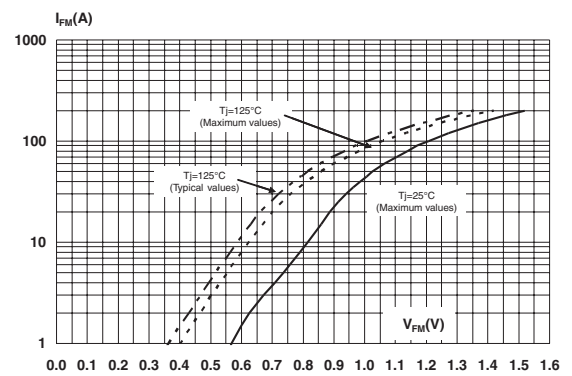
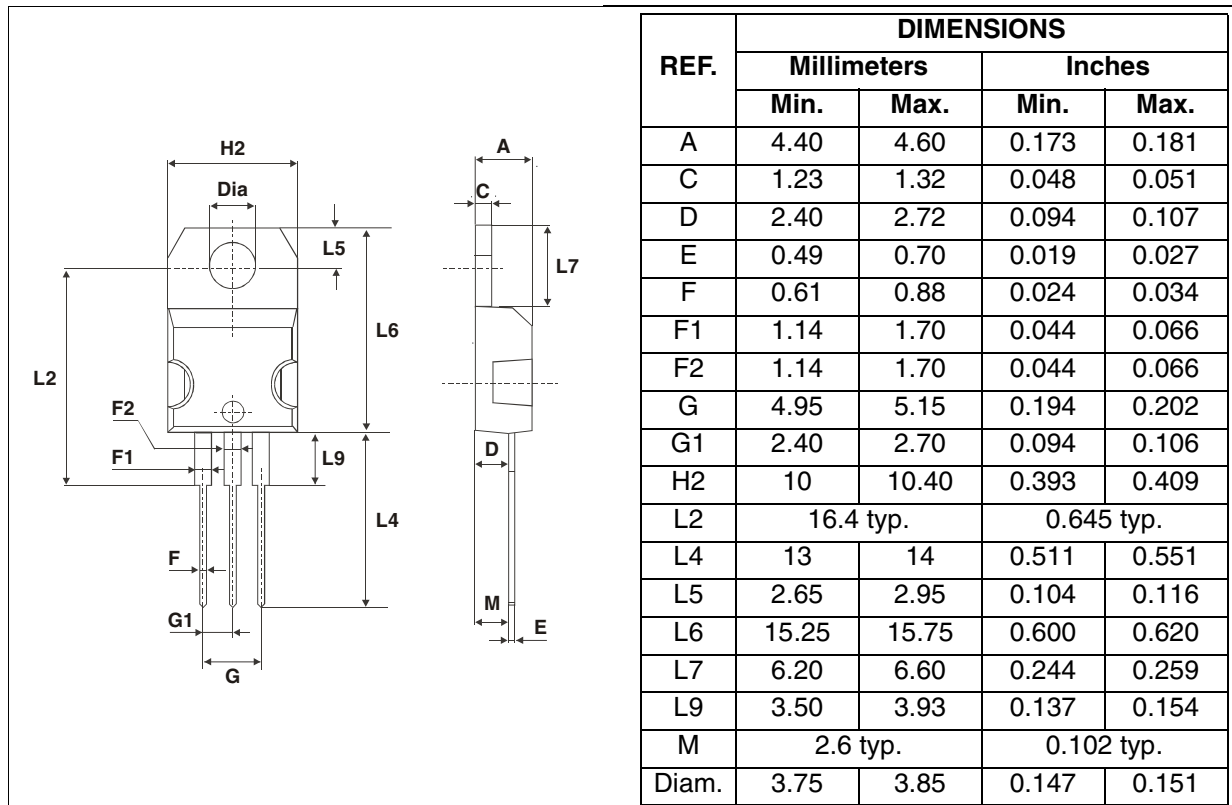

Figure 11: TO-220AB Package Mechanical Data



In order to meet environmental requirements, ST offers these devices in ECOPACK® packages. These packages have a Lead-free second level interconnect. The category of second level interconnect is marked on the package and on the inner box label, in compliance with JEDEC Standard JESD97. The maximum ratings related to soldering conditions are also marked on the inner box label. ECOPACK is an ST trademark. ECOPACK specifications are available at: www.st.com.

Table 6: Ordering Information

| Ordering type | Marking | Package | Weight | Base qty | Delivery mode |
|---------------|-------------|----------|--------|----------|---------------|
| STPS60170CT | STPS60170CT | TO-220AB | 2.20 g | 50 | Tube |

- Epoxy meets UL94, V0
- Cooling method: by conduction (C)
- Recommended torque value: 0.55 Nm.
- Maximum torque value: 0.7 Nm.

Table 7: Revision History

| Date | Revision | Description of Changes |
|-------------|----------|------------------------|
| 16-Sep-2005 | 1 | First issue. |

Information furnished is believed to be accurate and reliable. However, STMicroelectronics assumes no responsibility for the consequences of use of such information nor for any infringement of patents or other rights of third parties which may result from its use. No license is granted by implication or otherwise under any patent or patent rights of STMicroelectronics. Specifications mentioned in this publication are subject to change without notice. This publication supersedes and replaces all information previously supplied. STMicroelectronics products are not authorized for use as critical components in life support devices or systems without express written approval of STMicroelectronics.

The ST logo is a registered trademark of STMicroelectronics.
All other names are the property of their respective owners

© 2005 STMicroelectronics - All rights reserved

STMicroelectronics group of companies

Australia - Belgium - Brazil - Canada - China - Czech Republic - Finland - France - Germany - Hong Kong - India - Israel - Italy - Japan -
Malaysia - Malta - Morocco - Singapore - Spain - Sweden - Switzerland - United Kingdom - United States of America
www.st.com